

Thermo-economic Impact from Using Exhaust Gases Heat Lost for Power Generation

Hussam T. Khrebish

*Department of Mechanical Engineering
University of Basrah
College of Engineering
msc.hussam@gmail.com*

Dr. Hussien S. Sultan

*Department of Mechanical Engineering
University of Basrah
College of Engineering
Sajadhusseen@gmail.com*

Abstract- The heat lost from gas turbine power plants with exhaust gases represents the most important source for lowering its thermal efficiency. Also, the gas turbine thermal efficiency affected significantly with the ambient surrounding temperature. Al-Najybia gas-turbine power plant in Basrah, Iraq is choosing as a case study. The power plant consists of four units with a capacity of 125 MW for each unit. In the present study, all the calculations are performed for one unit only. Firstly the thermal impact is studied in terms of energy analysis for Al-Najybia gas turbine power plant (GTPP) for different ambient temperature for twelve months. Also, the economic loss accompanied the heat lost with exhaust gases for different ambient temperature are estimated. Secondly, the thermo-economic improvement from coupling the GTPP with a heat recovery system is studied. For gas-steam combined cycle, the performance and economic analysis are performed. The results show that, the output power and thermal efficiency are decreased by 0.97 MW and 0.0726% respectively for each unit temperature rise of the ambient temperature. For the combined gas-steam power plant the percentage increasing of the thermal efficiency is approximately 46.4%. The results indicate the combined cycle power plant (CCPP) is very important to increase electrical capacity. From the economic analysis, the economic gain due to using HRB is 75757 \$ per month.

Index Terms— *gas turbine, combined cycle and power generation.*

I. INTRODUCTION

Gas turbine is an internal combustion (IC) engine that uses atmospheric air and combustion gases as a working fluid, its used for electric power generation, operating aircraft, trains, ships and more industrial applications [1].

Gas turbine heat engines considered one of represents the most appropriate solutions to the problems of power in Iraq, and especially for hottest months in the year (about eight months in Basrah city from March to October). GTPP has the following characters, low capital cost and short time synchronization, a 30-minutes [2] (Time to reach basic load from zero speed for gas turbine), for electricity grid is stability, and due to the availability of fuel gas in many countries such as Iraq.

So, in the last few years, many gas turbine units have been established in Iraq, especially in a southern of Iraq in Al-Basrah. Where Al-Basrah contains more than five gas turbine

power plants, has been recently established to increase the power especially in summer season. GTPP is affected by the high temperature of the external environment, resulting in low power and efficiency. To increase power and efficiency of the gas turbine power plant, different methods can be used. The most importantly one is the use of exhaust gases coming out of the gas turbine for powering to a steam turbine in a cycle called the combined cycle.

Ali Marzouk and Abdalla Hanafi [2] indicated to the effect ambient temperature on the gas turbine power plant. In hot days, demand for energy increases while gas turbine power decreases. An 18% reduction in efficiency occurs at 40 ° C due to low air density and the resulting increase in compressor specific work.

Yusuf Siahaya [3] investigate by using energy and thermoeconomic analysis of GTPP which situated in Jakarta, Indonesia. He discussed a general methodology of these methods. He found, The exergoeconomic analysis suggested that decreasing the energy loss for components compressor, combustion chamber and gas turbine may lead to reduction in the electricity cost.

Valerie Eveloy et al. [4] enhanced the power generation capacity and efficiency by using waste heat recovery from the gas turbine unit, to produce a higher efficiency. The enhancement can by the thermal coupling of the gas turbine cycle with organic Rankine cycle. The results indicated an addition 5.2MW (23%) of net power is produced.

Lalatendue Pattanayak et al. [5] performed a performance evaluation for the CCPP under different operation conditions by applying the first law of thermodynamic analysis. The effect of ambient temperature on the efficiency of CCPP are estimated. The results shows that, the output power decreased with increasing the ambient temperature.

Emughiphel Nelson et al. [6] evaluated of the influence of ambient temperature on the performance of the trans-amadi gas turbine plant. The result shows that a 1°C rise of the ambient temperature is responsible for the following: 0% - 0.12% decrease in the power output, 0% - 1.17% decrease in the thermal efficiency.

II. THEORETICAL ANALYSIS

A. Thermodynamics Analysis (Energy Analysis) for Open Gas Turbine Cycle

In this section, the mathematical model for performance evaluation of Al-Najybia GTPP is reported. Overall system performance is evaluated under different operating conditions. the model gives the ability to evaluate the variation of the power output and the exhaust mass flow rate with ambient temperature. The scheme of the cycle is given in Fig .1.

Each component is indicated by numbers in the input and output. The characteristics of each point in the plant are indicated on the same number as can be seen in Fig .1.

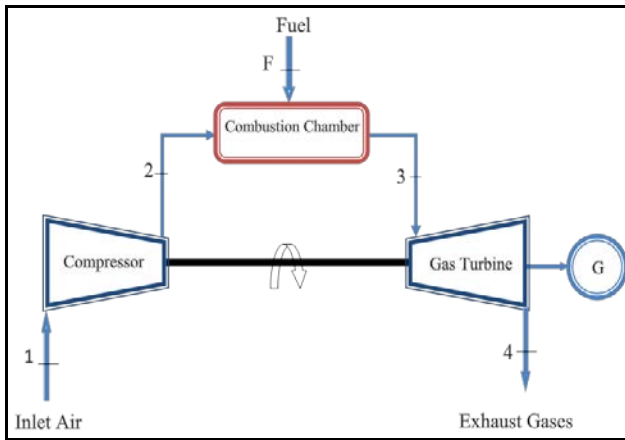

Fig .1The Open simple cycle Gas Turbine power plant.

Thermal efficiency and the electric output power of gas turbine units vary according to the ambient conditions (ambient temperature). The amount of these variations importantly affects electricity production and fuel consumption of the power plant.

The analysis of each component of the cycle shown in Fig .1is given below.

A.1. The Air Compressor

Gas turbine is known as a constant volume machine which means that, the total volume of the air inlet to compressor is constant. This volume is calculated at the ISO conditions of the gas turbine which are P=101.325 bar, T=15 °C, and relative humidity of (60%).

The air mass flow rate inlet the compressor is given by:

$$\dot{m}_a = \rho_a * v_{a_{rated}} \quad (1)$$

The isentropic efficiency for compressor $\eta_{is,C}$, can be evaluated using the following empirical relation [7]:

$$\eta_{is,C} = \left[1 - \left(0.04 + \frac{(r_p-1)}{150} \right) \right] \quad (2)$$

The actual outlet temperature of compressor is given by [7]:

$$\dot{T}_2 = \frac{T_2 - T_1}{\eta_{is,C}} + T_1 \quad (3)$$

The work required for the compressor is given by the relation:

$$\dot{W}_C = \dot{m}_a C_{Pa} (\dot{T}_2 - T_1) \quad (4)$$

A.2. The Combustion Chamber

The fuel is burned with air coming from the compressor in the combustion chamber.

The fuel ratio f is expressed as [6]:

$$f = \frac{\dot{m}_f}{\dot{m}_a} = \frac{C_{Pa} * T_3 - C_{Pa} * \dot{T}_2}{LHV - C_{Pg} * T_3} \quad (5)$$

The specific heat at constant pressure of air is a function of temperature is given by:

$$C_{Pa} (T) = 1.04841 - \frac{3.83719}{10^4} T + \frac{9.45378}{10^7} T^2 - \frac{5.49031}{10^{10}} T^3 + \frac{7.92981}{10^{14}} T^4 \quad (6)$$

Where the unit of temperature is Kelvin.

The specific heat at constant pressure of gases is given by [8]:

$$C_{Pg} (T) = 1.00397 - \frac{2.429}{10^5} T + \frac{1.63}{10^7} T^2 - \frac{6.966}{10^{11}} T^3 \quad (7)$$

A.3. The Gas Turbine

Products gases leave the combustion chamber, inlet the turbine at high temperature. High-temperature and pressure gases expand in turbines and produce work that converts to electrical energy in the generator.

The gases mass flow rate inlet the turbine is given by:

$$\dot{m}_g = \dot{m}_a + \dot{m}_f \quad (8)$$

The isentropic efficiency for gas turbine $\eta_{is,T}$, can be evaluated using the following empirical relation [7]:

$$\eta_{is,T} = \left[1 - \left(0.03 + \frac{(r_p-1)}{180} \right) \right] \quad (9)$$

The actual outlet temperature of turbine (exhaust temperature) is given by [9]:

$$\dot{T}_4 = T_3 - \eta_{is,T} * (T_3 - T_4) \quad (10)$$

The useful work from the gas turbine is given by the relation:

$$\dot{W}_T = \dot{m}_g C_{Pg} (T_3 - \dot{T}_4) \quad (11)$$

The net-work (output power) obtained from the gas turbine power plant is given by:

$$\dot{W}_{net} = \dot{W}_T - \dot{W}_C \quad (12)$$

The actual fuel mass flow rate per hour required of Al-Najybia power plant is calculated by:

$$\dot{m}_{f_{actual}} = 250 (m^3 / MWh) * \dot{W}_{net} (MW) \quad (13)$$

The theoretical fuel mass flow is given by:

$$\dot{m}_{f_{Theoretically}} = \dot{m}_f \left(\frac{kg}{s} \right) * 3600 / \rho_{gas} \quad (14)$$

The heat released from fuel combustion \dot{Q}_{in} is given by:

$$\dot{Q}_{in} = \dot{m}_f * LHV \quad (15)$$

The heat lost to the atmosphere \dot{Q}_L is given by:

$$\dot{Q}_L = \dot{m}_g * C_{P_g} (T_4 - T_1) \quad (16)$$

The Available heat that can be recovered from the exhaust gases by using heat recovery system is given by:

$$\dot{Q}_{Available\ Heat} = \dot{m}_g * C_{P_g} (T_4 - T_i) \quad (17)$$

Where T_i is the temperature of the exhaust gases exit from the heat recovery system.

Since the mass flow rate of the exhaust gases varies with the ambient temperature. In this study an average ambient temperature is calculated for each month. So, the exhaust gases mass flow rate will be charged from one month to another.

The average of the available heat for all month is given by:

$$\text{Average available heat} = \frac{\sum \dot{Q}_{per\ month}}{\text{No. of month}} \quad (18)$$

B. Thermodynamics Analysis (energy analysis) for Combined Cycle

One of the most important methods which can be used for improving the performance of GTPP is to combined it with steam turbine. Which means that, using the exhaust gases heat energy for steam generation.

In this section, a mathematical model for performance evaluation of Al-Najybia GTPP combined with simple steam power plant is reported.

The analysis of the gas turbine cycle is given in the previous section, the analysis of the steam turbine cycle and the overall combined cycle will be explained her.

The schematic of the combined cycle is shown in Fig.2 below.

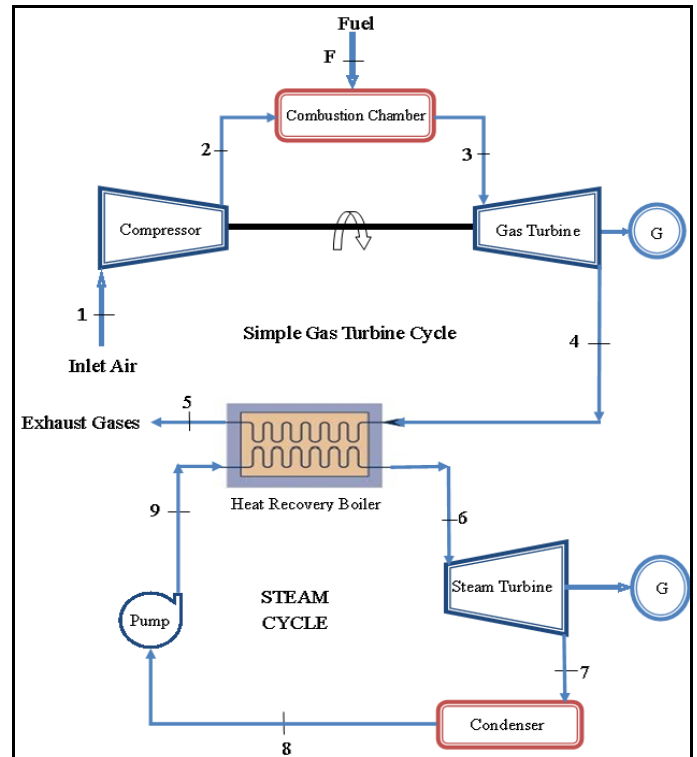

Fig. 1 Schematic of the combined gas-steam cycle.

In this cycle, energy is recovered from the exhaust gases by transferring it to the steam generated in the heat recovery boiler.

The governing equations of the combined cycle is given by the following [10]:

The energy balance on the heat recovery boiler is given by equation:

$$\dot{m}_s * (h_6 - h_9) = \dot{m}_g * C_{P_g} * (T_4 - T_i) \quad (19)$$

Where, $T_i = T_5$

The ratio of steam mass flow rate per gases mass flow rate is given by:

$$\frac{\dot{m}_s}{\dot{m}_g} = \frac{C_{P_g} * (T_4 - T_i)}{(h_6 - h_9)} \quad (20)$$

The steam mass flow rate is given by equation:

$$\dot{m}_s = \frac{\dot{m}_s}{\dot{m}_g} * \dot{m}_g \quad (21)$$

The equation of isentropic efficiency for steam turbine is given by [11]:

$$\eta_{is,ST} = \frac{h_6 - h_7'}{h_6 - h_7} \quad (22)$$

The actual work of steam turbine is given by [11]:

$$W_{net\ of\ Steam} = (h_6 - h_7) \quad (23)$$

The net work of combined cycle gas-steam is given by [10]:

$$W_{net.comb} = W_{net.GT} + \frac{\dot{m}_s}{\dot{m}_g} * W_{net.ST} \quad (24)$$

The thermal efficiency of the combined cycle is given by [10]:

$$\eta_{combined} = \frac{W_{net.combined}}{Q_{in,GT}} \quad (25)$$

C. The Economic Cost of Exhaust Gases and Cost of Available Exhaust Gases

The cost of the exhaust gases per kg is calculated from the cost of the fuel as given below:

$$C = \frac{C_0}{\rho_f} \quad (26)$$

The rate of fuel cost is given by:

$$\dot{C}_1 = C * \dot{m}_f \quad (27)$$

The cost of heat per kJ is given by:

$$C_2 = \frac{C_1}{\dot{Q}_f} \quad (28)$$

The cost rate of the exhaust gases of gas turbine unit alone is given by:

$$\dot{C}_3 = \dot{Q}_L * C_2 \quad (29)$$

The available economics that can be recovered by using a heat recovery system with the gas turbine units, the cost rate of available exhaust gases from gas turbine units is given by:

$$\dot{C}_4 = \dot{Q}_{Available\ heat} * C_2 \quad (30)$$

D. Economics of Combined Gas-Steam Power Plant, The Cost of Steam Generation Using Fuel Boiler and Exhaust Gases

The cost of steam required for driving the steam turbine is calculated for burned fuel boiler and also, for the heat recovery boiler. the difference between the two cost of steam generation represents the first economic gain. For the same mass flow rate of steam generated by the two boilers, the calculation is given below.

The cost of steam generation per kg for burned fuel boilers is given by:

$$C_G = C_f * (1 + 0.30) \quad (31)$$

The cost of fuel is approximately 90% of the total cost of the steam generation is given by:

$$C_f = C_2 * (h_s - h_w) / \eta_B \quad (32)$$

Where:

h_s : enthalpy of the steam (kJ/kg)

h_w : enthalpy of feed water boiler (kJ/kg)

η_B : the boiler efficiency

The 0.3 is a constant represents atypical value for several components cost used for steam generation except the fuel cost C_f .

The enthalpy of feed water boiler h_w is given by equation:

$$h_w = h_f + 0.001 (P_{Boiler} - P_{cond.}) \quad (33)$$

The enthalpy of steam h_s can be obtained from steam tables at any pressure and temperature.

Where:

h_f : the enthalpy of saturated liquid at condenser pressure

P_{Boiler} : the boiler pressure (kPa)

$P_{cond.}$: the condenser pressure (kPa)

The rate cost of steam generated using burned fuel boilers is given by:

$$\text{Cost of Steam} = \dot{m}_s * C_G \quad (34)$$

The cost of steam form heat recovery boiler is given by:

$$C_7 = 0.3 * C_f + C_4 \quad (35)$$

C_7 : Cost of steam using exhaust gases

The economic gain for using exhaust gases steam generation is given by:

$$\text{Gain cost} = \text{cost of steam} - C_7 \quad (36)$$

The second economic benefits from combined gas turbine with steam turbine is that, the economic gain from the increase in power generated is greater than the increase of the electrical power generation unit.

For the same mass flow rate of fuel supplied to the gas turbine unit, the increase in the power output due to combined the steam turbine is given below:

$$\text{The increase in power} = \text{the power output from combined plant} - \text{the power output from gas turbine unit} \quad (37)$$

So, the economic gain that can be obtained from power increasing is given by:

$$\text{The economic gain} = \text{the increase in power} * \text{cost electrical unit} \quad (38)$$

The cost for an electrical power production unit (C_e) is given:

$$C_e = \frac{\beta C_0}{H} + \frac{f}{\eta_o} + \frac{v}{WH} + V \quad (39)$$

Where:

$$\text{The total efficiency of the plant, } \eta_o = \frac{W}{Q} \quad (40)$$

β : The commission is based on the capital and depends on discount rate and the life of the station.

W : Plant capacity (kW).

H : Number of actual annual operating hours.

f : Fuel unit price (\$/kWh)

Q : The fuel energy consumption (kW)

The cost of maintenance and operation (OM), can be expressed as a sum of fixed operating costs U (\$/year), which include (employee wages, insurance, rent, administrative expenses, etc.) and variable operating costs V (\$/kWh), which include maintenance fees and spare parts.

III. RESULTS AND DISSCATION

In this section the results of the energy and economic analysis for Al Najybia GTPP will be viewed. The specifications for Al Najybia GTPP are given in Table I shown below. The analysis considered the effect of the ambient temperature for Basrah city for twelve month. The goal of the analysis is to explain effect of exhaust gases mass flow rate on the energy and economic efficiencies for different ambient temperatures.

In this section, the results of the previous cases mentioned in section two will be explained and discussed.

Table I gas turbine unit design data.

Item	Rate	Remarks
Gas turbine output	125 MW	At ISO condition
Air inlet temperature	15 °C	
Relative humidity	60 %	
Average air mass flow rate	407.8 kg/s	
Ambient pressure	1.013 bar	
Exhaust gases temperature	544.5 °C	
Exhaust gases flow rate	416 kg/s	
Compression ratio	12.5	
Fuel gas mass flow rate	8.2 kg/s	
Efficiency	35 %	

A. Validation of the Present Calculations

The calculations of the fuel mass flow rate for Al Najybia gas turbine power plant for twelve month are compared with actual fuel mass flow rate required for the power plant. The actual fuel mass flow rate is calculated form equation (13). The comparison of the results are given in Fig. 3 shown below. The percentage error between the theoretical and actual calculations is 2.29% which means there is acceptable convergence.

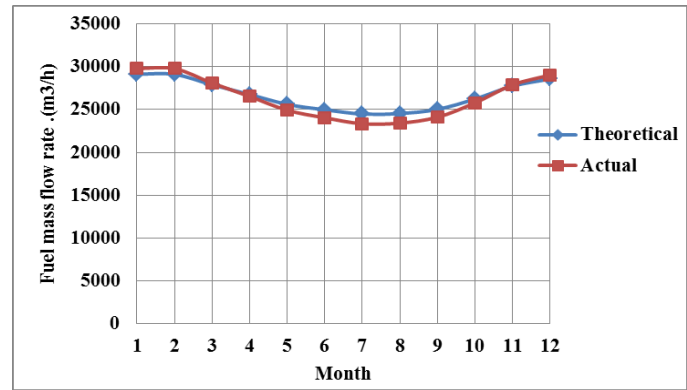

Fig. 3 Variation the actual fuel mass flow rate and theoretical for each month.

B. Effect of Ambient Temperature on the Exhaust Gases Mass Flow Rate

The mass flow rate of the exhaust gases from gas turbine depends on the mass flow rate of the inlet air to the compressor and the mass flow rate of the fuel added in the combustion chamber. Both the mass flow rate of air and fuel have different values for different values of ambient temperature. In this section the effect of ambient temperature on the inlet mass flow rate of air and fuel will be explained.

Gas turbine considered a constant volume machine [13] which means that, the volume of air inlet to the compressor is constant for all ambient conditions. So, when the ambient temperature increased the mass of air contained in the inlet volume will be different for different ambient temperature.

The calculations are performed for Al-Najybia GTPP for constant pressure ratio, TIT and exhaust gases temperature. The average ambient temperature for each month is given in Table II.

Table II average Ambient Temperature for each month [12].

Month	Average Ambient Temperature(°C)
January	20.5
February	20.6
March	27.7
April	34.6
May	42
June	46.2
July	49.6
August	49.3
September	45.9
October	38
November	28.6
December	23.7

For the average ambient temperatures given in Table II, the variation of the average exhaust gases mass flow rates with ambient temperature are given in the Fig. 4 and 5.

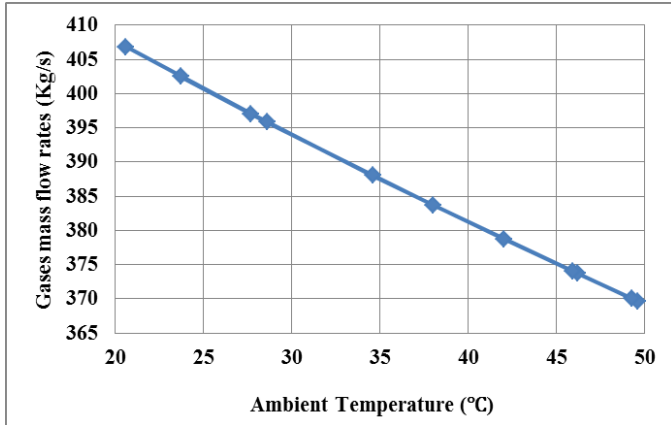

Fig. 4 Variation of Gases mass flow rates with ambient temperature.

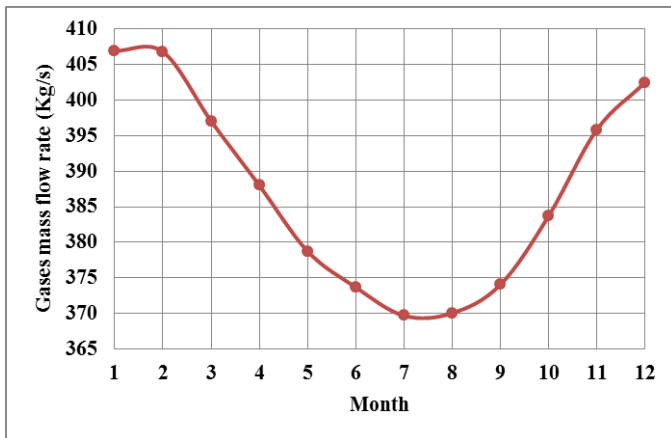

Fig. 5 Variations of exhaust gases mass flow rates for each month.

It's clear from Fig. 4 as the ambient temperature increased the gases mass flow rate is decreased, due to the air and fuel mass flow rates are decreased.

So, Fig. 5 shows the variation of exhaust gases mass flow rates for each month. It's clear that, the exhaust gases mass flow rate decreased for hot month and the minimum exhaust gases mass flow rate occurs in July month.

C. Effect of Ambient Temperature on Net Work of Gas Turbine Power Plant

The gas turbine output power depends on turbine output work and the compressor input work. Both the turbine and compressor work are changed with the ambient temperature variation.

For the average ambient temperature given in Table II the variation of the average net-work are given in Fig. 6.

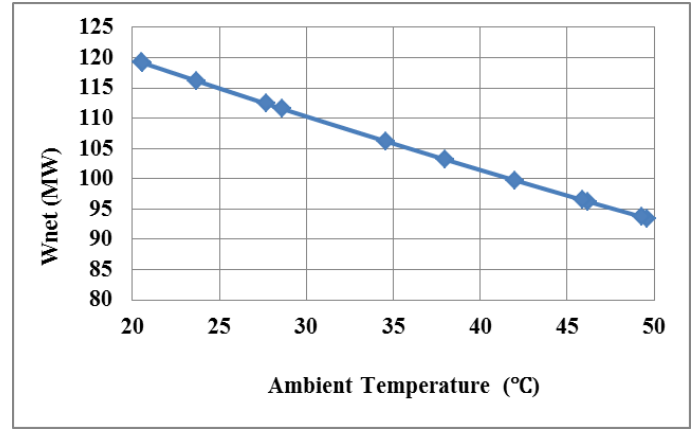

Fig. 6 variation of net work with ambient temperature.

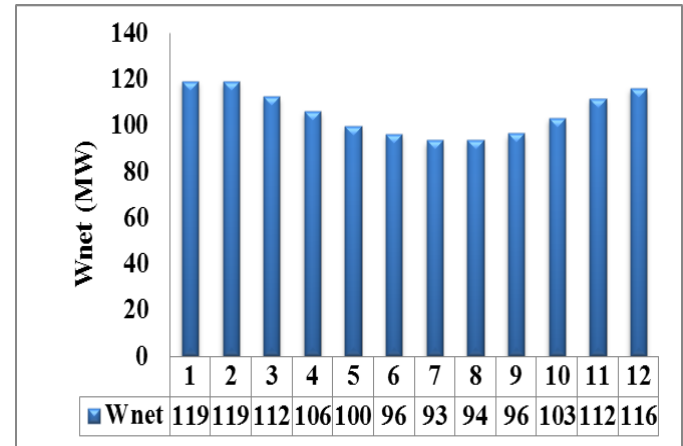

Fig. 7 variation of Net work with Month.

The net work decreased with increasing the ambient temperature as shown in Fig. 6 The net work decreased by 0.97 MW for each one degree increased in the ambient temperature.

Fig. 7 shows the variation of the net-work for each month. It's clear that, for hot month the network decreased and the minimum net work occurs in July and August. The maximum percentage of the reduction is 31.5 MW in the month of July.

D. Effect of Ambient Temperature on The Thermal Efficiency of Gas Turbine Power Plant

The effect of ambient temperature on the thermal efficiency and heat received by air in the combustion chamber for each month are given in Fig. 8,9 and 10.

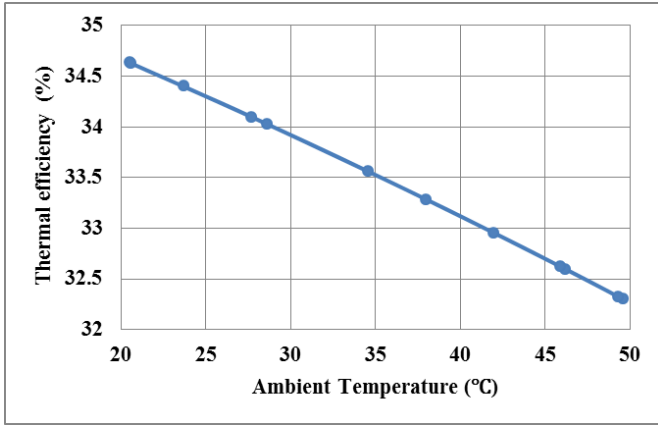

Fig.8 Variation of thermal efficiency with Ambient Temperature.

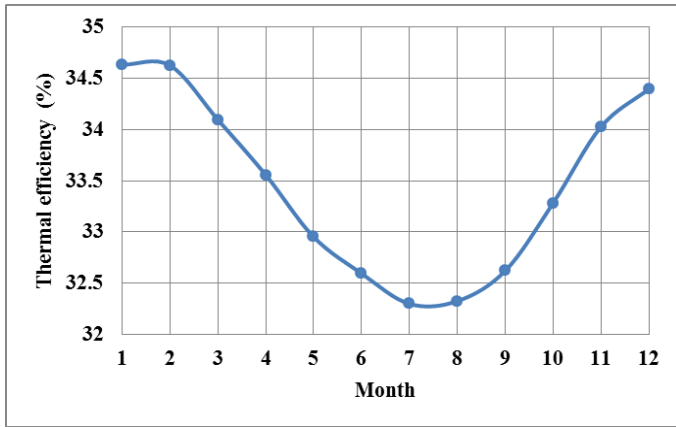

Fig. 9 Variation of thermal efficiency with Month of GTPP.

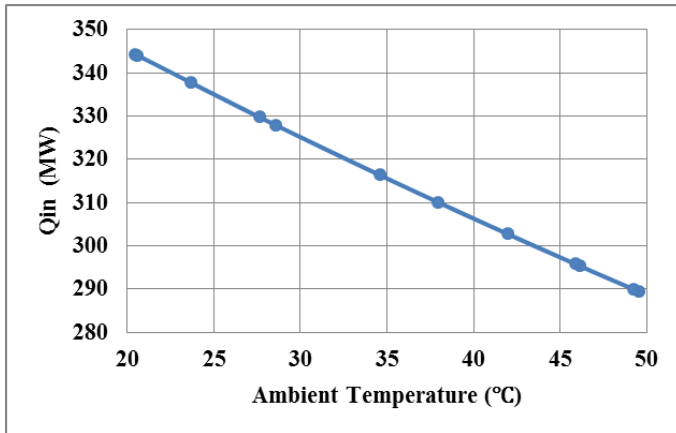

Fig. 10 Variation of heat received by the air in the combustion chamber with ambient temperature.

Fig. 8 shows that, the thermal efficiency of gas turbine power plant decreased with increasing the ambient temperature, due to the net work decreasing which is result from the increasing of the compressor work and the decreasing of the inlet air mass flow rate. The thermal efficiency decreased by 0.0726% for each unit temperature rise of the ambient temperature.

From Fig. 9 the minimum thermal efficiency occurs at the hottest months July and August. Also, from the figure the period of reduction in thermal efficiency starts from March and continue to November. This reduction due to the high ambient temperature for these months.

Also from Fig. 10 the heat received by the air in the combustion chamber decreased with increasing the ambient temperature. This reduction, due to decreasing the amount of fuel required in the combustion chamber for constant turbine inlet temperature which is result from the decreasing the mass flow rate of the air inlet to the combustion chamber. The heat received by the air in the combustion chamber decreased by 5.7 MW for each one degree increased in ambient temperature.

E. Effect of Ambient Temperature on The Heat Lost to The Atmosphere

The effect of ambient temperature on the amount of the heat lost to the atmosphere (heat of the exhaust gases) is given in Fig. 11.

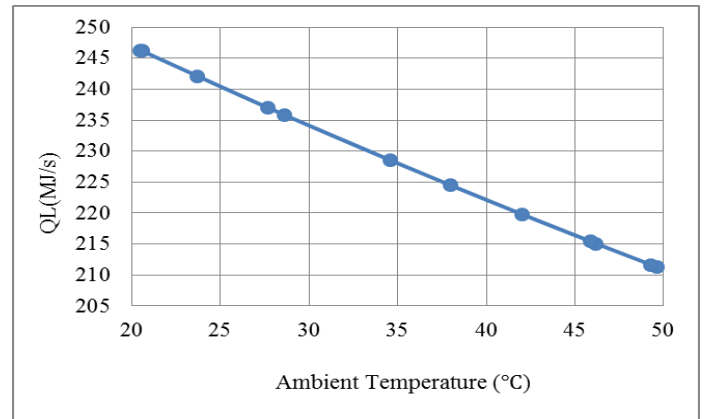

Fig. 11 Variation of the heat lost to the atmosphere with Ambient Temperature.

It's clear from Fig. 11, the heat lost to the atmosphere decreased as the ambient temperature increased, due to the decreasing of gases mass flow rate.

F. Effect of Ambient Temperature on The Available Heat

The amount of heat that can be recovered from the heat lost is called the available heat. This heat can be used for power generation, water desalination and others industrial processes. The amount of the available heat depends on the exhaust temperature from the heat recovery system. All heat recovery systems operates at exhaust temperature greater than 125°C to avoid the deposition of acids on the heat recovery surfaces and to boost the buoyancy force required for discharging the exhaust gases to the atmosphere.

In this study the exhaust temperature from the heat recovery system is assumed to be 150°C. So, the amount of the available heat for each month is given in Fig. 12 and 13.

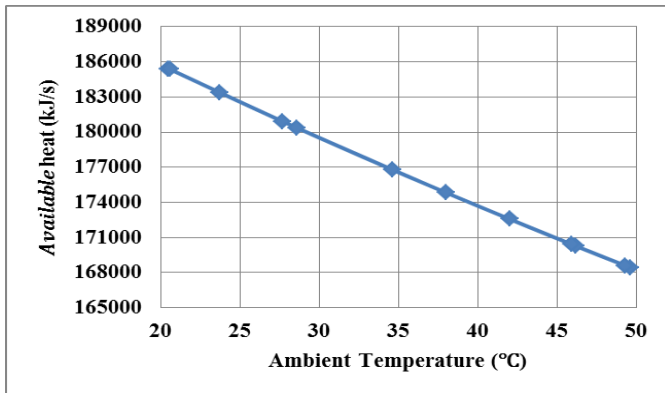

Fig. 12 variation of the available heat with Ambient Temperature.

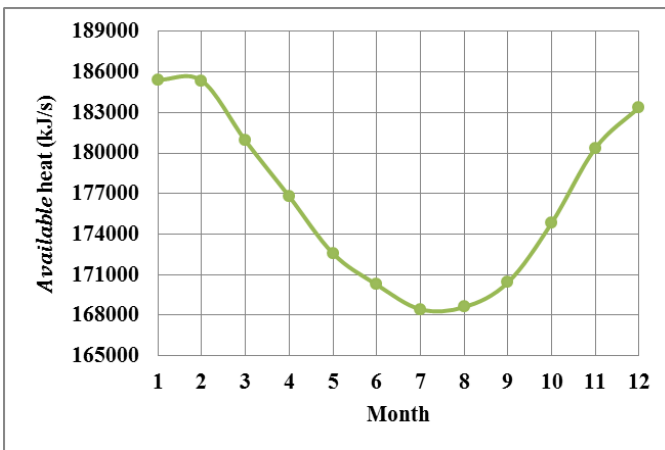

Fig. 13 Variation the available heat with Month of GTPP.

It's clear from Fig. 12 and 13, the available heat that can be recovered from the exhaust gases decreased as ambient temperature increased, due to the decreasing of the exhaust gases mass flow rate. The maximum decreasing in the available heat occurs at July month which is 9.157% as it is clear from Fig. 13.

G. Economic Impact of the Heat Lost and the Available Heat

The economic losses due to using gas turbine units as single system which is results from discharging the exhaust gases to the atmosphere without using heat recovery system. This economic losses was calculated depending on the cost of the fuel only.

In this study the case study is Al-Najybia gas turbine power plant. The fuel used is natural gas and its cost per cubic meter is 0.04 \$/m³ (50 ID/m³). So, the cost per unit heat is 9.39* 10⁻⁷ \$/kJ. The cost of the exhaust gases for each month is given in Fig. 14.

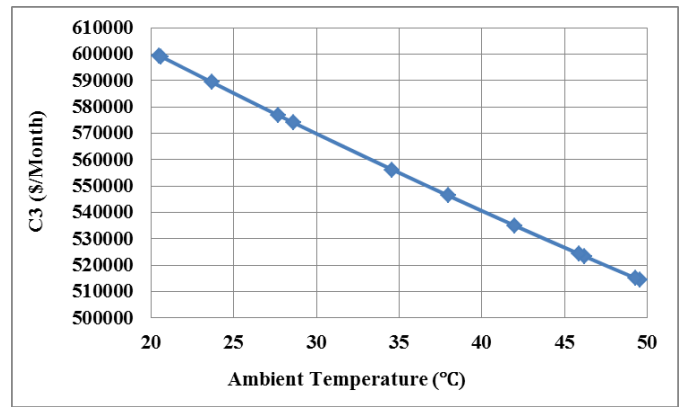

Fig. 14 variation of the cost of the exhaust gases with ambient temperature.

From the figure 14 shows that, the cost of the exhaust gases decreased as the ambient temperature increasing, due to the decreasing of the heat lost to the atmosphere from GTPP.

The available economic results from using heat recovery system with gas turbine units.

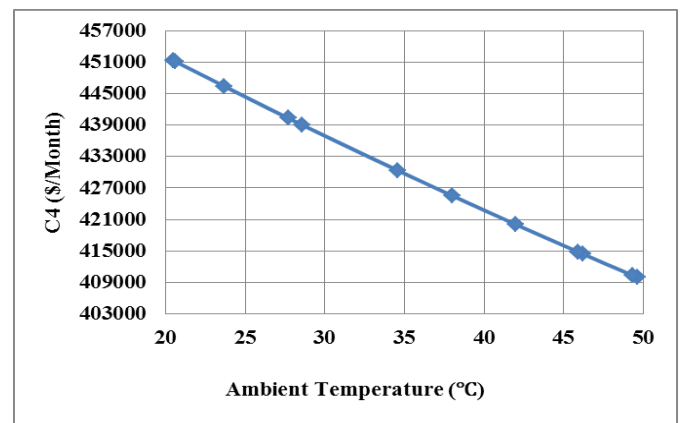

Fig. 15 variation of the available economic with ambient temperature.

From Fig. 15 shows that, the available economic decreased as the ambient temperature increasing, due to the decreasing the available heat recovered from the exhaust gases.

H. Using the Available Heat for Power Generation

One of the most important methods of gas turbine exhaust gases utilities is the using the available heat of the exhaust gases for steam generation in a heat recovery boiler. This steam is used for powering a steam turbine power plant.

H.1. Estimation of the Steam Mass Flow Rate

For constant amount of the exhaust gases (average value) inlet to the heat recovery boiler and constant temperature of steam exit from the boiler, the heat balance are performed for different operating pressure. The mass flow rate of steam generated is given in Fig. 16.

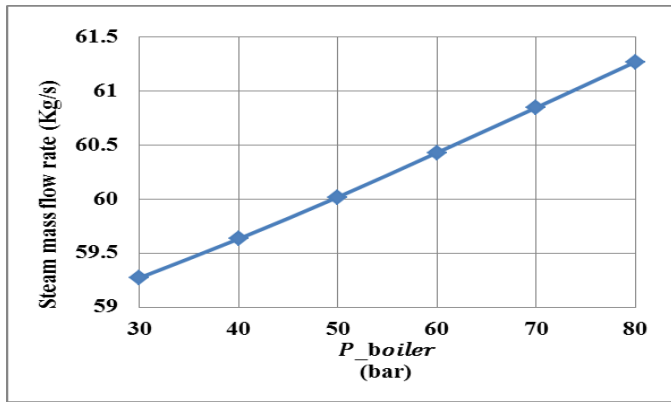

Fig. 16 Effect of boiler pressure on the steam mass flow rate.

It's clear from figure 16, as the boiler pressure increasing with exit steam temperature is constant, the mass flow rate of steam generated is increased due to the decreasing of the latent heat required for evaporation.

H.2. The Power of the Combined Cycle

For constant output power from gas turbine (average value), the output power from the combined gas-steam power plant for different operating pressures of the heat recovery boiler and constant condenser pressure is given in Fig. 17.

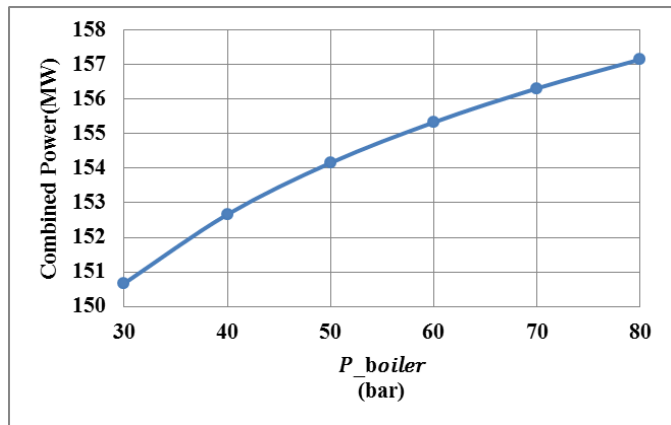

Fig. 17 variation of the combined power with boiler pressure.

It's clear from Fig.17 the power of the combined cycle increased with increasing boiler pressure, due to the increasing of steam turbine power. The percentage increasing of the power approximately 50%.

I. The Thermal Efficiency of Combined Power Plant

The thermal Efficiency of Combined Power Plant for different operating pressures of the heat recovery boiler and constant condenser pressure is given in Table III.

Table III The boiler pressure and thermal efficiency of CCP.

P_{Boiler} (bar)	$\eta_{th,combined}$
30	0.4779
40	0.4843
50	0.4890
60	0.4927
70	0.4958
80	0.4985

It's clear from Table III, the thermal efficiency of combined power plant increased with increasing the boiler pressure due to increasing the steam turbine net work. The percentage increasing of the efficiency approximately 46.4%.

J. Economics of the Combined Cycle

The cost of steam generation process represents one of the most source for the cost of the electricity generated in conventional fuel burned boilers power plants. In this section the cost of steam generated by burned fuel boilers is compared with that's generated using heat recovery boilers. The difference between the cost of steam generated unit by the two boilers (conventional and heat recovery boilers) represents one of the economic benefits from using the combined cycles.

J.1. The Cost of the Steam Generation Using Fuel Boiler

The cost of steam generation at different pressures for the boiler with constant temperature of the produced steam is given in Fig. 18.

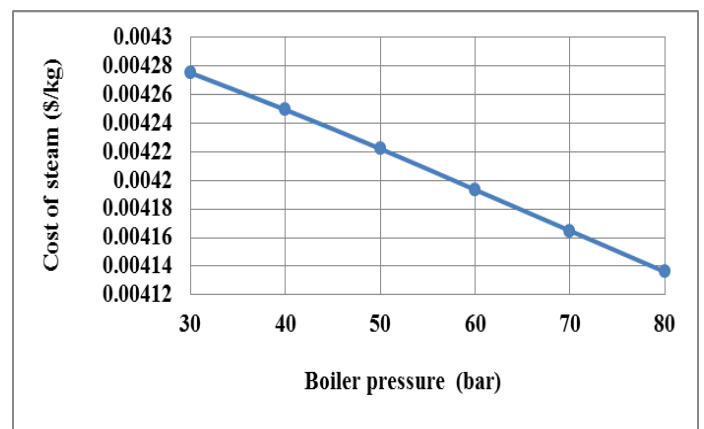

Fig. 18 variation of the cost of generating steam with boiler pressure.

Its clear from Fig. 18 that, the cost of steam generation decreased with increasing the boiler pressure. This reduction in steam cost results from decreasing the required heat input for the boiler when the pressure increased. So, the fuel mass flow rate required is decreased. The percentage reduction in steam cost is 1.9135%.

J.2. Estimation of the Cost of the Steam when Using Exhaust Gases for Steam Generation

The cost of steam generation using the heat recovery boiler is given in equation (35). In this equation the cost of fuel is replaced by the cost of the exhaust gases from the gas turbine unit. For constant amount of the exhaust gases inlet to the heat recovery boiler the cost of steam generation is given in Fig. 19.

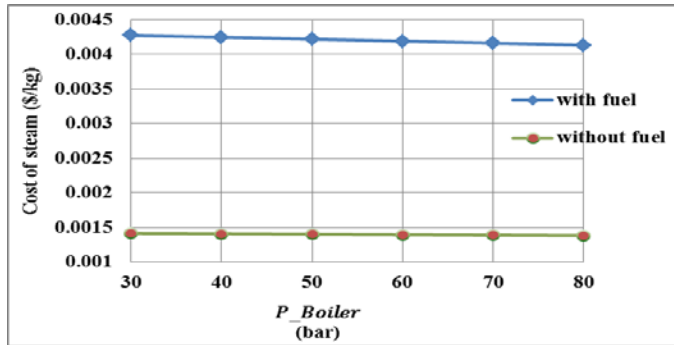

Fig. 19 the comparison for the cost of steam with and without fuel.

Its clear from Figure 19 that, the cost of steam using fuel burned is higher than using the exhaust gases from GTPP.

J.3. Estimation the Economic Gain from Steam Generation

The economic gain represents the difference between the cost of steam generation for fuel burned boiler and the heat recovery boiler. The economic gain per month is 75757 \$.

The second economic benefits from combined gas turbine with steam turbine is obtained from the increasing the output power. The economic gain due to the average increasing in the power is 867.524 \$ which is calculated from equation (38).

The data required for calculation the cost of the electrical power unit generation for gas turbine unit and the combined gas-steam power plant is given in Table IV.

Table IV data required for electric power unit cost, for gas turbine unit and combined cycle.

period	unit	Combined cycle	Gas turbine
C_o	\$/kW	686.666	542
β	%	6	6
H	h/year	8000	8000
f	\$/kWh	0.00338	0.00338
V	\$/kWh	0.005	0.005
U	% from C_o	1	1

The calculated cost for electrical power unit is given by Table below:

Station	C_e (\$/kWh)	C_e (\$/MWh)
Gas turbine power plant	0.01993	19.93
Combined power plant	0.01779	17.79

IV. COCLUTIONS

The main conclusions that can be drawn from this work are summarized as follows:

- 1- The ambient temperature has an impact on the performance of GTPP in terms of energy analysis, as the output power and efficiency decreasing with increase the ambient temperature.
- 2- The net work decreased by 0.97 MW for each one degree increased in the ambient temperature.
- 3- The thermal efficiency decreased by 0.0726% for each unit temperature rise of the ambient temperature.
- 4- The performance of GTPP enhanced when combined with steam turbine units.
- 5- Using the combined gas-steam power plant enhanced the performance of GTPP more than using inlet air cooling systems.
- 6- Combined power plant has the least cost of an electrical power production unit (C_e), compared with GTPP alone.

VII. REFERENCES

[1] Mahmood Farzaneh-Gord and Mahdi Deymi-Dashtebayaz," Effect of various inlet air cooling methods on gas turbine performance", Energy, 36, 1196-1205, (2011).

[2] Ali Marzouk And Abdalla Hanafi," Thermo-Economic Analysis Of Inlet Air Cooling In Gas Turbine Plants", Journal Of Power Technologies 93 (2) P.90-99, (2013).

[3] Yusuf Siahaya, " Thermo-economic Analysis And Optimization Of Gas Turbine Power Plant", Proceedings Of The International Conference On Fluid And Thermal Energy Conversion, Issn 0854-9346, December, (2009).

[4] Valerie Evely, Peter Rodgers, Adesola Olufade, Yuyao Wang and Ali Al Alili," Waste Heat Recovery from Gas Turbine Flue Gases for Power Generation Enhancement in a Process Plant", Int. J. of Thermal & Environmental Engineering, Volume 12, No. 1, 53-60 (2016).

[5] Lalatendu Pattanayak, Jaya Narayan Sahu, and Pravakar Mohanty," Combined cycle power plant performance evaluation using exergy and energy analysis", American Institute of Chemical Engineers, 36(4): p. 1180-1186, (2017).

[6] Emughiphel Nelson Igoma, Barinaada Thaddeus Lebele-Alawa And John Sodiki," Evaluation Of The Influence Of Ambient Temperature On The Performance Of The Trans-Amadi Gas Turbine Plant", Journal Of Power And Energy Engineering, 4, 19-31, Issn: 2327-5901 (2016).

[7] Rahim K. Jassim Majed M. Alhazmy And Galal M. Zaki," Energy, Exergy And Thermoeconomics Analysis Of Water Chiller Cooler For Gas Turbines Intake Air Cooling", Efficiency, Performance And Robustness Of Gas Turbines, Isbn 978-953-51-0464-3, (2012).

[8] Maher Al-Gburi, "Exergy Analysis Of Gas Turbine Power Plant In Iraq Al Najaf", School Of Natural And Applied Sciences, Çankaya University, (2015).

[9] Hossin Omar, Aly Kamel and Mohammed Alsanousi, " Performance of Regenerative Gas Turbine Power Plant", Energy and Power Engineering, ISSN: 1947-3818 , 9, 136-146, (2017).

[10] Yunus A. Cengel, Michael A. Boles, "Thermodynamics An Engineering Approach", Fifth Edition, Mcgraw Hill Companies, New York, USA, (2006).

[11] Claus Borgnakke And Richard E. Sonntag, "Fundamentals Of Thermodynamics", University Of Michigan, John Wiley & Sons, Inc, Seventh Edition, (2009).

[12] <http://www.tutiempo.net/>, (2018).

[13] Ahmed M. Bagabir, Jabril A. Khamaj And Ahmed S. Hassan , "Experimental And Theoretical Study Of Micro Gas Turbine Performance Augmentation" Emirates Journal For Engineering Research, 16 (2), 79-88 (2011).

VIII. BIOGRAPHIES



Hussien S. Sultan was born in Basrah – Iraq. He received his degree in Mechanical Engineering B.Sc. in 1999, M.Sc. in 2001, and PhD in Mechanical Engineering (Thermal-Mechanics) from Basrah University/Engineering College in 2011. He is currently an Associate Professor at the Mechanical Engineering Department, Basrah University to teach and supervise undergraduate, M.Sc. and PhD students.



Hussam Talib Khrebish was born in Basrah – Iraq. He received his degree in Mechanical Engineering B.Sc. in 2016.